

Technical Data Sheet

108-400ml TE Pot P1006

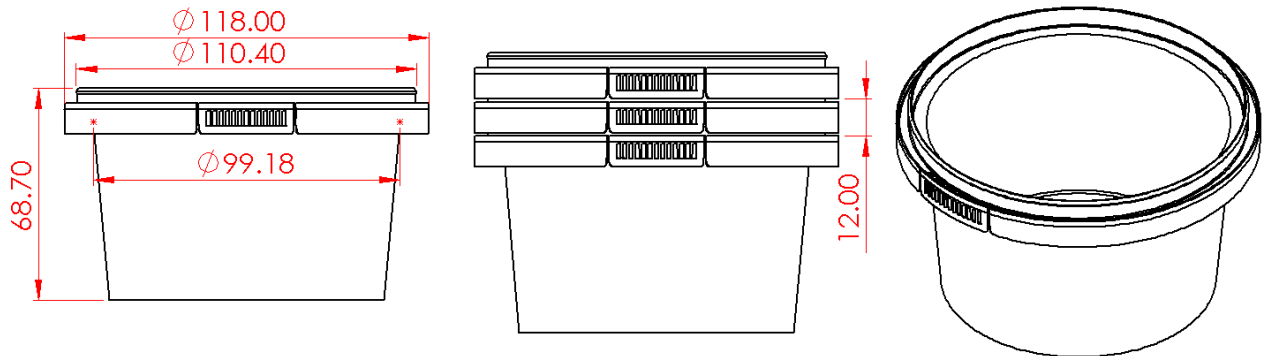

Profile:	Round Conical	Recycling No:	5
Tamper Evidence:	Tamper evident break out tab	Colours:	Natural, Clear, White. other colours available
Lid Style:	Sealing Lid	Decoration:	IML
Lid Options:	108 SK L2006	Food Safety:	Manufactured using HACCP certified process
Under Lid Volume:	430ml	No. Per Carton:	585
Raw Material:	Block or Random Copolymer	Carton Per Pallet:	30

Hot Filling:

The maximum fill temperature is 95° Celsius. Internal process trials should be undertaken to validate the viability of this product for its intended use.

Freezing:

The standard resin used for natural coloured products will resist temperatures down to minus -5° Celsius. Deep freezing below this temperature will be subject to alternate resins upon request, the standard resin used for these products may become brittle at temperatures below 0° Celsius. Internal process trials should be undertaken to validate the viability of this product for its intended use.

Re-Heating:

This product may be microwaved. Internal process trials should be undertaken to validate the viability of this product for its intended use.

Shelf Life:

The compliance of the product to the technical specifications in this data sheet is guaranteed for 12 months after the date of delivery.

Stacking:

EMPTY: Full cartons of product should be stacked no more than 5 high.
FULL: It is recommended that this product be packed into self-supporting trays or cardboard boxes. Internal process trials should be undertaken.

Microwave & Dishwasher Safe:

Yes, Resins are dishwasher safe and are designed for reusability. For all situations internal trials should be instigated to assess the viability of the product for its intended use.

Recycling:



All Packit Packaging products are recyclable, and should be disposed of responsibly in your kerbside recycling or at "don't forget it recycle it" collection points.

ALL SPECIFICATIONS NOTED IN THE TECHNICAL DATA SHEET ARE SUBJECT TO REVISION WITHOUT NOTICE